

Varenummer: 20192B35B35562BL
Beskrivelse: E+G
T-rørs holder GN192-B35-B35-56-2-BL

Mål

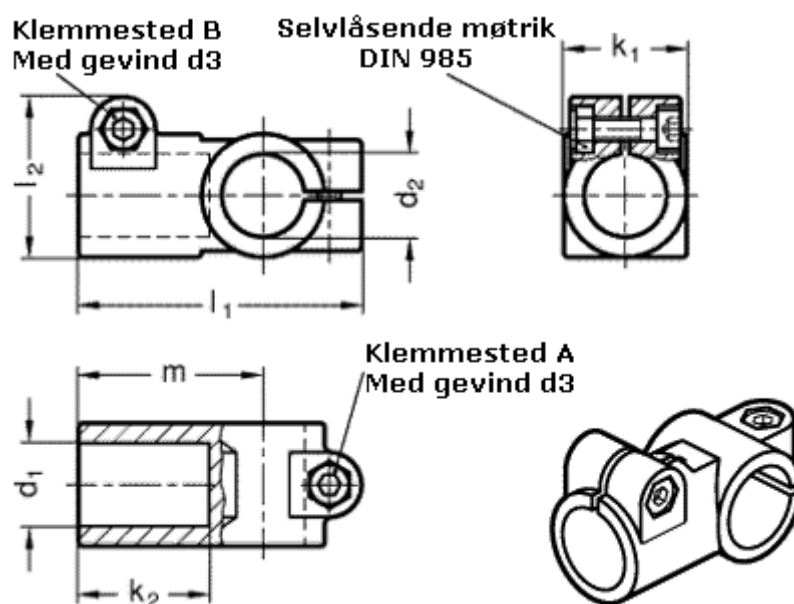

d1 = B35
d2 = B35
d3 = M10
k1 = 56
k2 = 62.0
l1 = 129
l2 = 69.0
m = 88